



3-port seat valves, external thread, PN 16

VXG41..

- Bronze CuSn5Zn5Pb2 valve body
- DN 15...50
- k_{vs} 1.6...40 m³/h
- Flat sealing connections with external thread G...B to ISO 228-1
- Sets of ALG..3 screwed fittings with threaded connection available from Siemens
- Can be equipped with SQX.. electromotoric or SKD.. and SKB.. electrohydraulic actuators
- VXG41..01 3-port seat valves are DVGW tested



Use

For use in heating, ventilating and air conditioning systems as a control valve for mixing and diverting functions. For closed and open circuits (mind «cavitation» on page 4).
VXG41..01 Three-port seat valves for distribution or supply of cold water to storage or heat exchanger for hot water treatment in the drinking water installation.

Type summary

Type / stock no.		DN	k_{vs} [m ³ /h]	S_v
	VXG41.1301 ¹⁾	15	1,6	> 50
	VXG41.1401 ¹⁾		2,5	
VXG41.15	VXG41.1501 ¹⁾		4,0	
VXG41.20	VXG41.2001 ¹⁾	20	6,3	> 100
VXG41.25	VXG41.2501 ¹⁾	25	10	
VXG41.32	VXG41.3201 ¹⁾	32	16	
VXG41.40	VXG41.4001 ¹⁾	40	25	
VXG41.50	VXG41.5001 ¹⁾	50	40	

¹⁾ These types, as a standard, are equipped with a tight bypass. DVGW verified, DVGW applications according to drinking water regulation 2001. For medium temperatures up to 90 °C

DN = Nominal size

k_{vs} = Nominal flow rate of cold water (5...30 °C) through the fully open valve (H_{100}) by a differential pressure of 100 kPa (1 bar)

S_v = Rangeability k_{vs} / k_{vr}

k_{vr} = Smallest k_v value, at which the flow characteristic tolerances can still be maintained, by a differential pressure of 100 kPa (1 bar)

Accessories

Type	Stock No.	Description
ALG..3 ¹⁾	ALG..3	Set of 3 screwed fittings for 3-port valves, consisting of - 3 union nuts, 3 discs and 3 flat seals ALG..3B are brass fittings, for media temperatures up to 100 °C.
ALG..3B ¹⁾	S55846-Z1..	
ASZ6.5	ASZ6.5	Electric stem heating element, AC 24 V 30 W, required for media below 0 °C

¹⁾ Applications requiring union fittings with DVGW approval must be delivered by thirds.

Order

When ordering please give type, stock no., designation and quantity.

Example:

Type	Stock no.	Designation	Quantity
VXG41.2501	VXG41.2501	Valve	2
ALG253B	S55846-Z105	Set of screwed fittings	2

Delivery

Valves, actuators and accessories are packed and supplied separately.

Spare parts, rev. no.

See overview, page 9.

Equipment combinations

Valves		Actuators						Fitting sets		
		SQX.. ¹⁾		SKD.. ¹⁾		SKB..		Type / stock no.	Type	Stock no.
		Mixing	Diverting	Mixing	Diverting	Mixing	Diverting	Malleable cast iron	Brass	
	VXG41.1301	800	200 ²⁾	800	200 ²⁾	800	200 ²⁾			
	VXG41.1401									
VXG41.15	VXG41.1501									
VXG41.20	VXG41.2001									
VXG41.25	VXG41.2501									
VXG41.32	VXG41.3201									
VXG41.40	VXG41.4001	525	150 ²⁾	775	150 ²⁾	150 ²⁾	ALG403	ALG403B	S55846-Z109	
VXG41.50	VXG41.5001	300	100 ²⁾	450	100 ²⁾	100 ²⁾	ALG503	ALG503B	S55846-Z111	

¹⁾ Usable up to maximum medium temperature of 150 °C

²⁾ If noise is permitted, the same values apply as for the mixing valve.

Δp_{max} = Maximum permissible differential pressure across valve's control path, valid for the entire actuating range of the motorized valve

Actuator overview

Type	Actuator type	Operating voltage	Positioning signal	Spring return	Positioning time	Positioning force	Data sheet
SQX32.00	Electro-motoric	AC 230 V	3-position	No	150 s	700 N	N4554
SQX32.03					35 s		
SQX82.00		AC 24 V			150 s		
SQX82.03					35 s		
SQX62					DC 0...10 V ¹⁾		
SKD32.50	Electro-hydraulic	AC 230 V	3- position	No	120 s	1000 N	N4563
SKD32.21				Yes	30 s		
SKD32.51		AC 24 V		No	120 s		
SKD82.50				Yes			
SKD82.51				No			
SKD60		DC 0...10 V ¹⁾		Yes	30 s		
SKD62..				No			
SKB32.50	Electro-hydraulic	AC 230 V	3- position	No	120 s	2800 N	N4564
SKB32.51				Yes			
SKB82.50		AC 24 V		No			
SKB82.51				Yes			
SKB60				DC 0...10 V ¹⁾			
SKB62..		Yes					

¹⁾ or DC 4...20 mA

Note: Pneumatic actuators are available on request from your local office or branch.
Application is possible only if the VXG41.. is used as a mixing valve.

Technical design / mechanical design

Valve cross section

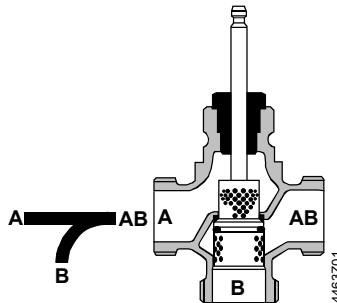

Guided perforated plug which is integrated in the valve stem.

A pressed-in stainless steel seat ring is used as seat A – AB.

Flow diagram
«Mixing»

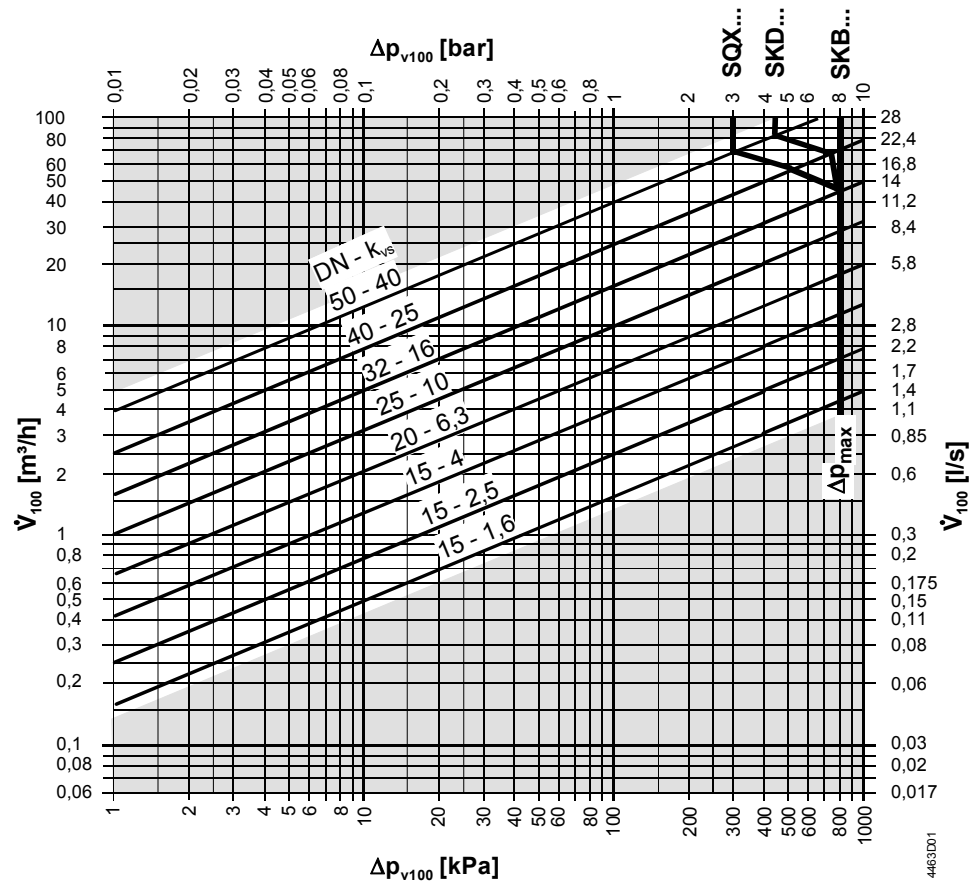

- Δp_{max} = Maximum permissible differential pressure across the valve (mixing: port A - AB, B - AB), valid for the entire actuating range of the motorized valve
- Δp_{v100} = Differential pressure across the fully open valve and the valve's control path A - AB, B - AB by a volume flow V_{100}
- \dot{V}_{100} = Volume flow through the fully open valve (H_{100})
- 100 kPa = 1 bar \approx 10 mWC
- 1 m³/h = 0.278 l/s water at 20 °C

Valve flow characteristic

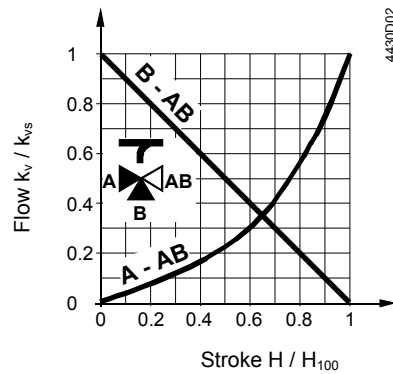

Through-port

- 0 ... 30 %: linear
- 30 ... 100 %: equal-percentage $n_{gl} = 3$ to VDI / VDE 2173

Bypass

- 0...100 %: linear

Mixing: flow from port A and port B to port AB

Diverting: flow from port AB to port A and port B

- Port I = constant flow
- Port II = variable flow
- Port III = bypass (variable flow)

Use the 3-port valve primarily as a mixing valve.

Cavitation

Cavitation accelerates wear on the valve plug and seat, and also results in undesirable noise. Cavitation can be avoided by not exceeding the differential pressure shown in the flow diagram on page 4, and by adhering to the static pressures shown below.

Note on chilled water

To avoid cavitation in chilled water circuits ensure sufficient counter pressure at valve outlet, e.g. by a throttling valve after the heat exchanger. Select the pressure drop across the valve at maximum according to the 80 °C curve in the flow diagram below.

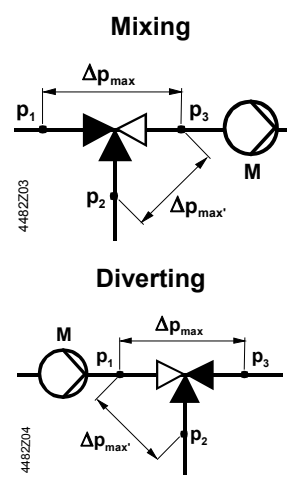
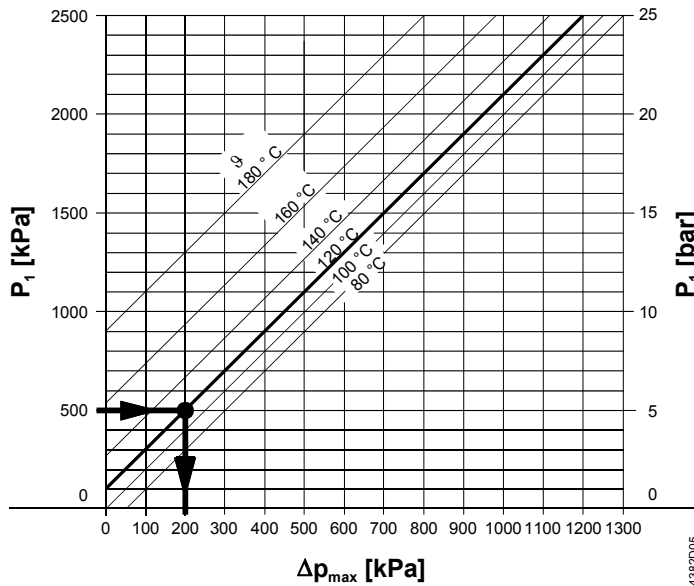

- Δp_{max} = Differential pressure with valve almost closed, at which cavitation can largely be avoided
- ... Situation for bypass
- p_1 = Static pressure at inlet
- p_2 = Static pressure at outlet
- M = Pump
- ϑ = Water temperature

High temperature hot water example:

Pressure p_1 at valve inlet: 500 kPa (5 bar)
 Water temperature: 120 °C

From the diagram above, it will be seen that with the valve almost closed, the maximum permissible differential pressure Δp_{max} is 200 kPa (2 bar).

Working pressure and temperature

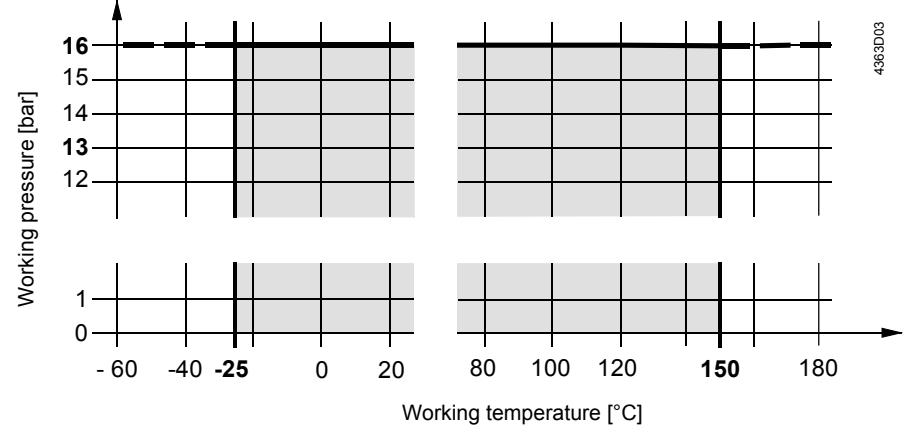

Working pressure and medium temperature staged as per ISO 7005

Current local legislation must be observed.

Notes

Engineering In open circuits, there is a risk of valve plug seizing caused by scale deposits. Thus, use only the most powerful actuator SKB... for these applications. Additionally, periodic actuation (twice or three times per week) must be planned. With closed and open circuits always use a strainer upstream of the valve to increase the valve's functional safety.

Ensure cavitation-free flow, refer to page 5.

To ensure the reliability of the valve, we recommend the fitting of a strainer at the valve inlet in closed and open circuits.



For media below 0 °C, use the electric ASZ6.5 stem heating element to prevent the valve stem from freezing in the sealing gland. For safety reasons, the stem heating element has been designed for AC 24 V / 30 W operating voltage.

Mounting

Both valve and actuator can easily be assembled at the mounting location. Neither special tools nor adjustments are required.

The valve is supplied with Mounting Instructions 4 319 9563 0.

Orientation

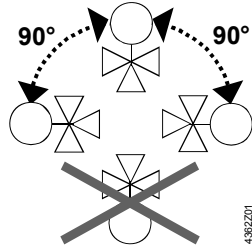

Direction of flow

When mounting, pay attention to the valve's flow direction symbol →:

Mixing from
A / B to AB



Diverting from
AB to A / B

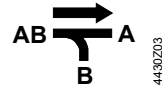

Commissioning



Commission the valve only if the actuator has been mounted correctly.

Valve stem retracts: through-port A – AB opens, bypass B closes

Valve stem extends: through-port A – AB closes, bypass B opens

Maintenance

VXG41... valves require no maintenance.

Warning

When doing service work on the valve / actuator:

- Deactivate the pump and turn off the power supply
- Close the shutoff valves
- Fully reduce the pressure in the piping system and allow pipes to completely cool down

If necessary, disconnect the electrical wires.

Before putting the valve into operation again, make certain the actuator is correctly fitted.

Stem sealing gland

The glands can be exchanged without removing the valve, provided the pipes are depressurized and cooled off and the stem surface is unharmed, refer to «spare parts», page 9.

If the stem is damaged in the gland range, replace the entire stem-plug-unit.

Contact your local office or branch.

Disposal

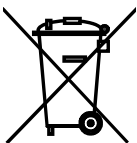

Before disposal the valve must be dismantled and separated into its various constituent materials.

Legislation may demand special handling of certain components, or it may be sensible from an ecological point of view.

Current local legislation must be observed.

Warranty

The technical data given for these applications is valid only in conjunction with the Siemens actuators as detailed under «Equipment combinations», page 2. All terms of the warranty will be invalidated by the use of actuators from other manufacturers.

Technical data

Functional data	PN class	PN 16 to ISO 7268	
	Operating pressure	to ISO 7005 within the permissible medium temperature range according to the diagram on page 5	
	Flow characteristic	<ul style="list-style-type: none"> • Through-port 0...30 % • linear • Through-port 30...100 % • equal percentage; $n_{gl} = 3$ to VDI / VDE 2173 • Bypass 0...100% • linear 	
	Leakage rate	• Through-port	0...0.02 % of k_{vs} value to DIN EN 1349
		• Bypass standard version	0.5...2% of k_{vs} value
		• Bypass VXG41..01	0...0.02% of k_{vs} value
	Permissible media	water	cooling water, chilled water, low temperature hot water, high temperature hot water, water with anti-freeze; recommendation: water treatment to VDI 2035
		drinking water	VXG41..01, < 90 °C
	Medium temperature ¹⁾		-25... 150 °C
		DVGW applications, VXG41..01, chilled- and low temperature hot water	max. 90 °C
	Industry standards	Rangeability S_v	DN 15: > 50 DN ≥20: >100
		Nominal stroke	20 mm
		Pressure Equipment Directive	PED 97/23/EC
Pressure Accessories		as per article 1, section 2.1.4	
Fluid group 2		without CE-marking as per article 3, section 3 (sound engineering practice)	
DVGW approval No.		DW-6341BU0025	
Environmental compatibility			ISO 14001 (Environment)
			ISO 9001 (Quality)
			SN 36350 (Environmentally compatible products) RL 2002/95/EG (RoHS)
Materials		Valve body	bronze CuSn5Zn5Pb2
	Seat, plug, stem	stainless steel	
	Sealing gland	dezincification-free brass, silicon-free	
	gland materials	EPDM O rings, silicon-free	
Dimensions / Weight	Refer to «Dimensions»		
	External thread connections	G..B to ISO 228-1	

¹⁾ Media below 0 °C: ASZ6.5 stem heating element required to prevent freezing of the valve stem in the sealing gland.
With ALG..B fittings for media temperature up to 100 °C
Applications requiring union fittings with DVGW approval must be delivered by thirds.

Dimensions

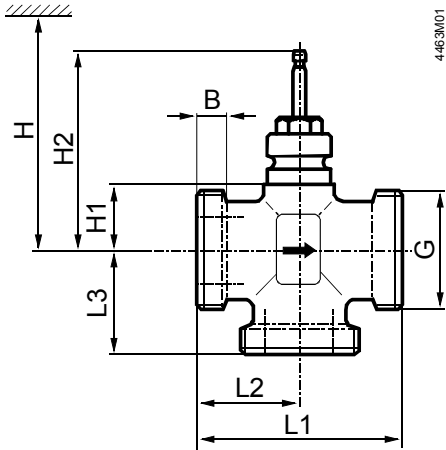

DN = Nominal size

H = Total actuator height plus minimum distance to the wall or the ceiling for mounting, connection, operation, service, etc.

H1 = Dimension from the pipe centre to install the actuator (upper edge)

H2 = Valve in the «Closed» position means that the stem is fully extended

Type	DN	B [mm]	G [inch]	L1 [mm]	L2 [mm]	L3 [mm]	H1 [mm]	H2 [mm]	H			kg
									SQX...	SKD...	SKB...	[kg]
VXG41.1301	15	10	G1B	100	50	50	26	122.5	> 451	> 526	> 601	1.30
VXG41.1401												
VXG41.15	VXG41.1501	20	G1½B	105	52.5	52.5	34	130.5	> 459	> 534	> 609	1.65
VXG41.20	VXG41.2001											
VXG41.25	VXG41.2501	14	G1½B	105	52.5	52.5	34	130.5	> 459	> 534	> 609	2.10
VXG41.32	VXG41.3201											
VXG41.40	VXG41.4001	16	G2¾B	150	75	75	46	142.5	> 471	> 546	> 621	3.90
VXG41.50	VXG41.5001											

Screwed fittings

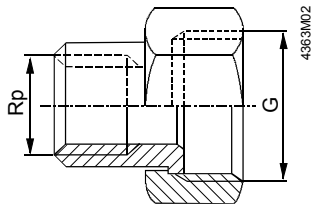

Type / Stock No.	Type	Stock No.	for valve type	G [inch]	Rp [inch]
ALG153	ALG153B	S55846-Z101	VXG41.13...15	G 1	Rp ½
ALG203	ALG203B	S55846-Z103	VXG41.20..	G 1¼	Rp ¾
ALG253	ALG253B	S55846-Z105	VXG41.25..	G 1½	Rp 1
ALG323	ALG323B	S55846-Z107	VXG41.32..	G 2	Rp 1¼
ALG403	ALG403B	S55846-Z109	VXG41.40..	G 2¼	Rp 1½
ALG503	ALG503B	S55846-Z111	VXG41.50..	G 2¾	Rp 2

- On valve side: cylindrical thread to ISO 228-1
- On pipe side: with cylindrical thread to ISO 7-1
- For drinking water applications according to DVGW drinking water regulation 2001 screwed fittings must be obtained from local dealer.
- ALG..B for media temperatures up to 100 °C
- Applications requiring union fittings with DVGW approval must be delivered by thirds.

Spare parts

Order numbers for spare parts

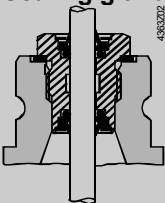
Type	DN	Sealing gland	Set
			Plug with stem, circlip, sealing
VXG41.1301	15	74 284 0047 0	74 676 0166 0
VXG41.1401	15	74 284 0047 0	74 676 0167 0
VXG41.15	15	4 284 8874 0	74 676 0135 0
VXG41.1501	15	74 284 0047 0	74 676 0137 0
VXG41.20	20	4 284 8874 0	74 676 0121 0
VXG41.2001	20	74 284 0047 0	74 676 0126 0
VXG41.25	25	4 284 8874 0	74 676 0122 0
VXG41.2501	25	74 284 0047 0	74 676 0127 0
VXG41.32	32	4 284 8874 0	74 676 0123 0
VXG41.3201	32	74 284 0047 0	74 676 0128 0
VXG41.40	40	4 284 8874 0	74 676 0124 0
VXG41.4001	40	74 284 0047 0	74 676 0129 0
VXG41.50	50	4 284 8874 0	74 676 0125 0
VXG41.5001	50	74 284 0047 0	74 676 0130 0

Revision numbers

Type	Valid from rev. no.	Type	Valid from rev. no.	Type	Valid from rev. no.
VXG41.1301	..B	VXG41.2001	..B	VXG41.40	..A
VXG41.1401	..B	VXG41.25	..A	VXG41.4001	..B
VXG41.15	..A	VXG41.2501	..B	VXG41.50	..A
VXG41.1501	..B	VXG41.32	..A	VXG41.5001	..B
VXG41.20	..A	VXG41.3201	..B		

