



## Electrohydraulic actuators for valves

with a 20 mm stroke

**SKD32..**  
**SKD82..**  
**SKD62..**  
**SKD60..**

- **SKD32..** Operating voltage AC 230 V, 3-position control signal
- **SKD82..** Operating voltage AC 24 V, 3-position control signal
- **SKD6..** Operating voltage AC 24 V, control signal DC 0...10 V, 4...20 mA or 0...1000 Ω
- **SKD6..** Choice of flow characteristic, position feedback, stroke calibration, LED status indication, override control
- **SKD62UA** with functions choice of direction of operation, stroke limit control, sequence control with adjustable start point and operating range, operation of frost protection monitors QAF21.. and QAF61..
- **Positioning force 1000 N**
- **Actuator versions with or without spring-return function**
- **For direct mounting on valves; no adjustments required**
- **Manual adjuster and position indicator**
- **Optional functions with auxiliary switches, potentiometer, stem heater and mechanical stroke inverter**
- **SKD..U are UL-approved**

### Use

For the operation of Siemens 2-port and 3-port valves, types VVF.., VVG.., VXF.. and VXG.. with a 20 mm stroke as control and safety shut-off valves in heating, ventilation and air conditioning systems.

## Types

	Type	Operating voltage	Positioning signal	Spring-return		Positioning time		Enhanced functions
				Function	Time	Opening	Closing	
Standard electronics	SKD32.50	AC 230 V	3-position			120 s	120 s	
	SKD32.51			yes	8 s	30 s	10 s	
	SKD32.21							
	SKD82.50	AC 24 V				120 s	120 s	
	SKD82.50U *							
	SKD82.51			yes	8 s			
Enhanced electronics	SKD82.51U *							
	SKD62	AC 24 V	DC 0...10 V, 4...20 mA, or 0...1000 Ω	yes	15 s	30 s	15 s	yes <sup>1)</sup>
	SKD62U *							
	SKD60							
SKD60U *								
	SKD62UA *			yes	15 s			

<sup>1)</sup> Direction of operation, stroke limit control, sequence control, signal addition

\* UL-approved versions

## Accessories

Type	Description	For actuator	Mounting location
ASC1.6	Auxiliary switch	SKD6..	1 x ASC 1.6
ASC9.3	Dual auxiliary switches	SKD32.. SKD82..	1 x ASC9.3 and
ASZ7.3	Potentiometer 1000 Ω		1 x ASZ7.3 or
ASZ7.31	Potentiometer 135 Ω		1 x ASZ7.31 or
ASZ7.32	Potentiometer 200 Ω		1 x ASZ7.32
ASZ6.6	Stem heater AC 24 V	SKD..	1 x ASZ6.6
ASK50	Mechanical stroke inverter		1 x ASK50

## Ordering

When ordering please specify the quantity, product name and type code.

*Example: 1 actuator, type SKD32.50 and*

*1 potentiometer, 135 Ω, type ASZ7.31*

## Delivery

The actuator, valve and accessories are supplied in separate packaging and not assembled prior to delivery.

## Spare parts

See overview, section «Replacement parts», page 18.

## Equipment combinations

Valve type		DN	PN-class	$k_{vs}$ [m <sup>3</sup> /h]	data sheet
<b>Two-port valves VV...</b> (control valves or safety shut-off valves):					
VVF21.. <sup>1)</sup>	Flange	25...80	6	1.9...100	4310
VVF22..	Flange	25...80	6	2.5...100	4401
VVF31.. <sup>1)</sup>	Flange	15...80	10	2.5...100	4320
VVF32..	Flange	15...80	10	1.6...100	4402
VVF40.. <sup>1)</sup>	Flange	15...80	16	1.9...100	4330
VVF42..	Flange	15...80	16	1.6...100	4403
VVF41.. <sup>1)</sup>	Flange	50	16	19...31	4340
VVF53..	Flange	15...50	25	0.16...40	4405
VVF52.. <sup>1)</sup>	Flange	15...40	25	0.16...25	4373
VVF61..	Flange	15...50	40	0.19...31	4382
VVG41..	Threaded	15...50	16	0.63...40	4363
<b>Three-port valves VX...</b> (control valves for «mixing» and «distribution»):					
VXF21.. <sup>1)</sup>	Flange	25...80	6	1.9...100	4410
VXF22..	Flange	25...80	6	2.5...100	4401
VXF31.. <sup>1)</sup>	Flange	15...80	10	2.5...100	4420
VXF32..	Flange	15...80	10	1.6...100	4402
VXF40.. <sup>1)</sup>	Flange	15...80	16	1.9...100	4430
VXF42..	Flange	15...80	16	1.6...100	4403
VXF41.. <sup>1)</sup>	Flange	15...50	16	1.9...31	4440
VXF53..	Flange	15...50	25	1.6...40	4405
VXF61..	Flange	15...50	40	1.9...31	4482
VXG41..	Threaded	15...50	16	1.6...40	4463

For admissible differential pressures  $\Delta p_{max}$  and closing pressures  $\Delta p_s$ , refer to the relevant valve data sheets.

<sup>1)</sup> Valves are phased-out

**Note** Third-party valves with strokes between 6...20 mm can be motorized, provided they are «closed with the de-energized» fail-safe mechanism and provided that the necessary mechanical coupling is available. For SKD32.. and SKD82.. the Y1 signal must be routed via an additional freely-adjustable end switch (ASC9.3) to limit the stroke.

We recommend that you contact your local Siemens office for the necessary information.

**Rev. no.** Overview table, see page 18.

## Technology

### Principle of electro-hydraulic actuators

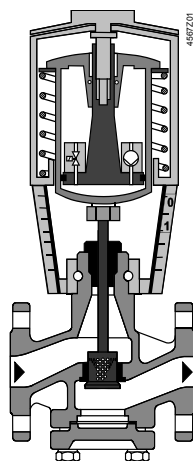

Valve closed

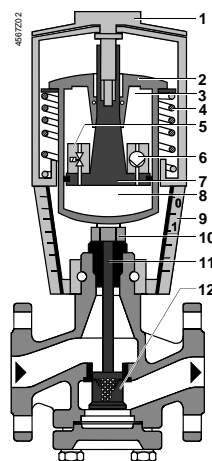

Valve open

- 1 Manual adjuster
- 2 Pressure cylinder
- 3 Suction chamber
- 4 Return spring
- 5 Solenoid valve
- 6 Hydraulic pump
- 7 Piston
- 8 Pressure chamber
- 9 Position indicator (0 to 1)
- 10 Coupling
- 11 Valve stem
- 12 Plug



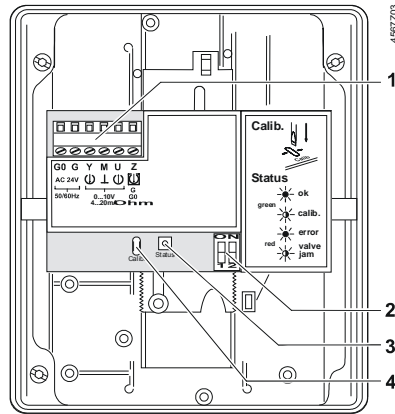

Opening the valve	The hydraulic pump (6) forces oil from the suction chamber (3) to the pressure chamber (8) and thereby moving the pressure cylinder (2) downwards. The valve stem (11) retracts and the valve opens. Simultaneously the return spring (4) is compressed.
Closing the valve	Activating the solenoid valve (5) allows the oil in the pressure chamber to flow back into the suction chamber. The compressed return spring moves the pressure cylinder upwards. The valve stem extends and the valve closes
Manual operation mode	Turning the manual adjuster (1) clockwise moves the pressure cylinder downwards and opens the valve. Simultaneously the return spring is compressed. In the manual operation mode the control signals Y and Z can further open the valve but cannot move to the «0%» stroke position of the valve. To retain the manually set position, switch off the power supply or disconnect the control signals Y and Z. The red indicator marked «MAN» is visible.
Note: Controller in manual operation	When setting the controller for a longer time period to manual operation, we recommend adjusting the actuator with the manual adjuster to the desired position. This guarantees that the actuator remains in this position for that time period. Attention: Do not forget to switch back to automatic operation after the controller is set back to automatic control.
Automatic mode	Turn the manual adjuster counterclockwise to the end stop. The pressure cylinder moves upward to the «0%» stroke position of the valve. The red indicator marked «MAN» is no longer visible.
Minimal volumetric flow	The actuator can manually be adjusted to a stroke position > 0 % allowing its use in applications requiring constantly a minimal volumetric flow.
<b>Spring-return facility</b>	The SKD32.51, SKD32.21, SKD82.51.. and SKD62.. actuators, which feature a spring-return function, incorporate a solenoid valve which opens if the control signal or power fails. The return spring causes the actuator to move to the «0 %» stroke position and closes the valve.
<b>SKD32../SKD82..</b> 3-position control signal	The actuator is controlled by a 3-position signal either via terminals Y1 or Y2 and generates the desired stroke by means of above described principle of operation. <ul style="list-style-type: none"> <li>• Voltage on Y1                      piston extends                      valve opens</li> <li>• Voltage on Y2                      piston retracts                      valve closes</li> <li>• No voltage on Y1 and Y2      piston / valve stem remain in the respective position</li> </ul>
<b>SKD62..., SKD60..</b> Y control signal DC 0...10 V and/or DC 4...20 mA, 0...1000 Ω	The valve is either controlled via terminal Y or override control Z. The positioning signal Y generates the desired stroke by means of above described principle of operation. <ul style="list-style-type: none"> <li>• Signal Y increasing:              piston extends                      valve opens</li> <li>• Signal Y decreasing:              piston retracts                      valve closes</li> <li>• Signal Y constant:                piston / valve stem remain in the respective position</li> <li>• Override control Z                see description of override control input, page 8</li> </ul>
Frost protection monitor Frost protection thermostat	A frost protection thermostat can be connected to the SKD6.. actuator. The added signals from the QAF21.. and QAF61.. require the use of SKD62UA actuators. Notes on special programming of the electronics are described under «Enhanced electronics» on page 5.  «Connection diagrams» for operation with frost protection thermostat or frost protection monitor refer to page 15.

**Standard electronics**  
SKD62..., SKD60..



- 1 Connection terminals
- 2 Mode DIL switches
- 3 LED status indication
- 4 Slot for calibration

**DIL switches**  
SKD62..., SKD60..

	Positioning signal Y Position feedback U	Flow characteristic
<b>ON</b>	 DC 4...20 mA	 lin = linear
<b>OFF *)</b>	 DC 0...10 V	 log = equal percentage

\*) Factory setting:  
All switches OFF

Relationship  
between control  
signal Y and  
volumetric flow

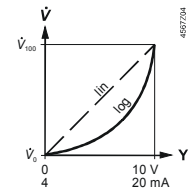



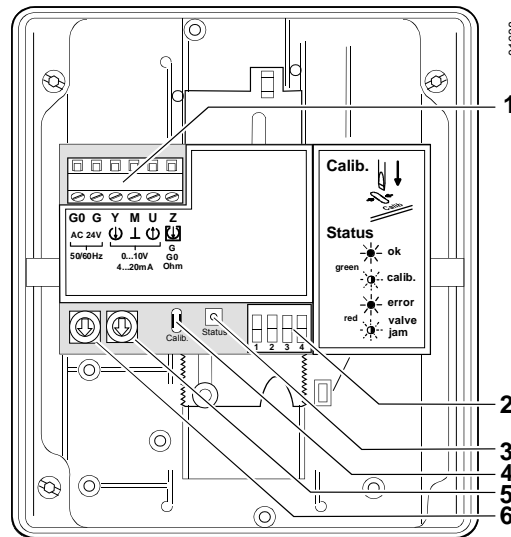





**Enhanced electronics**  
SKD62UA



- 1 Connection terminals
- 2 DIL switches
- 3 LED status indication
- 4 Stroke calibration
- 5 Rotary switch **Up** (factory setting 0)
- 6 Rotary switch **Lo**

**DIL switches**  
SKD62UA

	Direction of operation	Sequence control or stroke limit control	Control signal Y Position feedback U	Flow characteristic
<b>ON</b>	 reverse-acting	 Sequence control Signal addition QAF21../QAF61..	 DC 4...20 mA	 lin = linear
<b>OFF *</b>	 direct-acting	 Stroke limit control	 DC 0...10 V	 log = equal percentage

\* Factory settings: all switches OFF

Relationship  
between control  
signal Y and  
volumetric flow

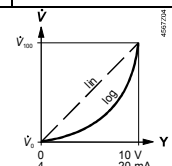

Selection of direction of operation  
SKD62UA

- With normally-closed valves, «direct-acting» means that with a signal input of 0 V, the valve closes (applies to all Siemens valves listed under «equipment combinations» on page 3)
- With normally-open valves, «direct-acting» means that with a signal input of 0 V, the valve is open.

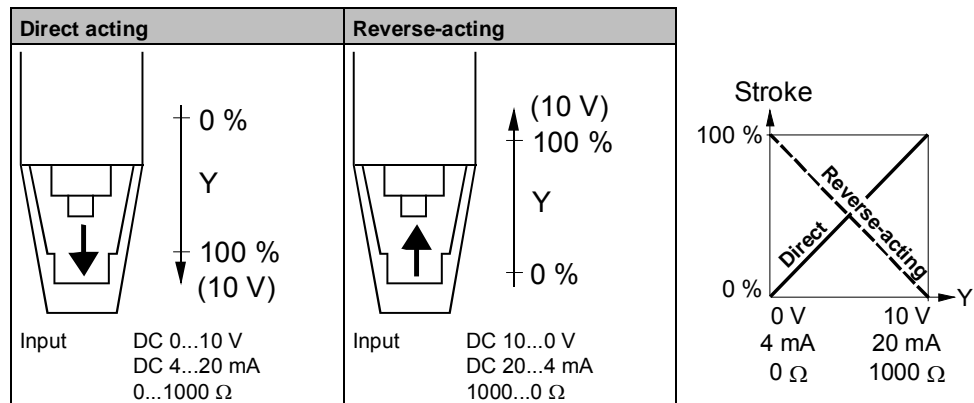

Note The mechanical spring-return function is not affected by the direction of operation selected.

Stroke limit control and sequence control  
SKD62UA

**Setting the stroke limit control**

The rotary switches LO and UP can be used to apply an upper and lower limit to the stroke in increments of 3%, up to a maximum of 45%

Position of LO	Lower stroke limit	Position of UP	Upper stroke limit
0	0 %	0	100 %
1	3 %	1	97 %
2	6 %	2	94 %
3	9 %	3	91 %
4	12 %	4	88 %
5	15 %	5	85 %
6	18 %	6	82 %
7	21 %	7	79 %
8	24 %	8	76 %
9	27 %	9	73 %
A	30 %	A	70 %
B	33 %	B	67 %
C	36 %	C	64 %
D	39 %	D	61 %
E	42 %	E	58 %
F	45 %	F	55 %

**Setting the sequence control**

The rotary switches LO and UP can be used to determine the starting point or the operating range of a sequence.

Position of LO	Starting point for sequence control	Position of UP	Operating range of sequence control
0	0 V	0	10 V
1	1 V	1	10 V *
2	2 V	2	10 V **
3	3 V	3	3 V ***
4	4 V	4	4 V
5	5 V	5	5 V
6	6 V	6	6 V
7	7 V	7	7 V
8	8 V	8	8 V
9	9 V	9	9 V
A	10 V	A	10 V
B	11 V	B	11 V
C	12 V	C	12 V
D	13 V	D	13 V
E	14 V	E	14 V
F	15 V	F	15 V

\* Operating range of QAF21.. (see below)  
 \*\* Operating range of QAF61.. (see below)  
 \*\*\* The smallest adjustment is 3 V; control with 0...30 V is only possible via Y.

Stroke control with QAF21.. / QAF61.. signal addition  
SKD62UA only

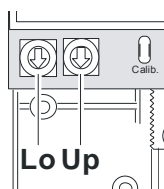

**Setting the signal addition**

The operating range of the frost protection monitor (QAF21.. or QAF61..) can be defined with rotary switches LO and UP.

Position of LO	Sequence control start point	Position of UP	QAF21.. / QAF61.. operating range
0		1	QAF21..
0		2	QAF61..

**Calibration**  
SKD62.., SKD60..

In order to determine the stroke positions 0 % and 100 % in the valve, calibration is required on initial commissioning:

**Prerequisites**

- Mechanical coupling of the actuator SKD6.. with a Siemens valve
-  **Actuator must be in «Automatic operation» enabling stroke calibration to capture the effective 0 % and 100 % values**
- AC 24 V power supply
- Housing cover removed

**Calibration**

1. Short-circuit contacts in calibration slot (e.g. with a screwdriver)
2. Actuator moves to «0 %» stroke position (1) (valve closed)
3. Actuator moves to «100 %» stroke position (2) (valve open)
4. Measured values are stored

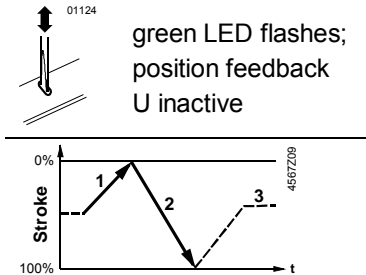

**Normal operation**







- |  |  |
|--|--|
| 5. Actuator moves to the position (3) as indicated by signals Y or Z | green LED is lit permanently;<br>position feedback U active, the values correspond to the actual positions |
|--|--|

A lit red LED indicates a calibration error.

The calibration can be repeated any number of times.

The LED status indication indicates operational status with dual-colored LED and is visible with removed cover.

**Indication of operating state**  
SKD62.., SKD60..

LED	Indication	Function	Remarks, troubleshooting
<b>Green</b>	Lit 	Normal operation	Automatic operation; everything o.k.
	Flashing 	Calibration in progress	Wait until calibration is finished (LED stops flashing, green or red LED will be lit)
<b>Red</b>	Lit 	Faulty stroke calibration	Check mounting Restart stroke calibration (by short-circuiting calibration slot)
	Flashing 	Internal error	Replace electronics
<b>Both</b>	Dark 	Inner valve jammed	Check valve
	Dark 	No power supply Electronics faulty	Check mains network, check wiring Replace electronics

As a general rule, the LED can assume only the states shown above (continuously red or green, flashing red or green, or off).

**Override control input Z**  
SKD62..., SKD60..

Override control input can be operated in following different modes of operation

		<b>Z-mode</b>				
		no function	fully open	closed	override with 0...1000 Ω	Signal addition SKD62UA only
<b>Connections</b>						
	<b>Transfer</b>					
		linear or equal-percentage			linear or equal-percentage	linear or equal-percentage
		<ul style="list-style-type: none"> <li>Z-contact not connected</li> <li>Valve stroke follows Y-input</li> </ul>	<ul style="list-style-type: none"> <li>Z-contact connected directly to G</li> <li>Y-input has no effect</li> </ul>	<ul style="list-style-type: none"> <li>Z-contact connected directly to G0</li> <li>Y-input has no effect</li> </ul>	<ul style="list-style-type: none"> <li>Z-contact connected to M via resistor R</li> <li>Starting position at 50 Ω / end position at 900 Ω</li> <li>Y-input has no effect</li> </ul>	<ul style="list-style-type: none"> <li>Z-contact is connected to R of the frost protection monitor QAF21.. or QAF61..</li> <li>Valve stroke follows signals Y and R(Z)</li> </ul>

Note Shown operation modes are based on the factory setting «direct acting»  
Y-input has no effect in Z-mode.

**Accessories**

**SKD..**

**ASZ6.6 (S55845-Z108)**  
stem heater

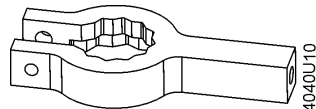

- for media below 0 °C
- mount between valve and actuator

**SKD32..., SKD82..**

**ASC9.3**  
double auxiliary switch

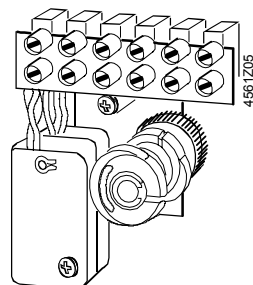

adjustable switching points

**ASZ7.3..**  
potentiometer

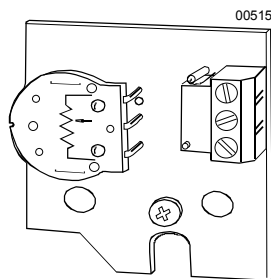

- ASZ7.3: 0...1000 Ω
- ASZ7.31: 0...135 Ω
- ASZ7.32: 0...200 Ω

**ASK50**  
stroke inverter

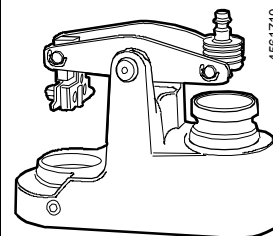

0 % actuator stroke corresponds to 100 % valve stroke; mount between valve and actuator



**ASC1.6**

auxiliary switch

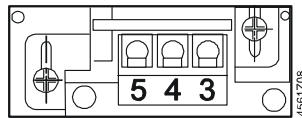

switching point 0...5 % stroke

See section «Technical data» on page 12 for more information.

**Engineering notes****Caution** ⚠

Conduct the electrical connections in accordance with local regulations on electrical installations as well as the internal or connection diagrams.

**Safety regulations and restrictions designed to ensure the safety of people and property must be observed at all times!**



**The plant operator must also ensure compliance with applicable guidelines on cable insulation when using a safety limiter. Failure to comply may cause the safety limiter function to fail.**

**Caution** ⚠

**For media below 0 °C the ASZ6.6 stem heater is required to keep the valve from freezing. For safety reasons the stem heater is designed for an operating voltage of AC 24 V / 30 W.**

**For this case, do not insulate the actuator bracket and the valve stem, as air circulation must be ensured. Do not touch the hot parts without prior protective measures to avoid burns.**

**Non-observance of the above may result in accidents and fires!**

**Recommendation: Above 140 °C insulating the valves is strictly recommended.**

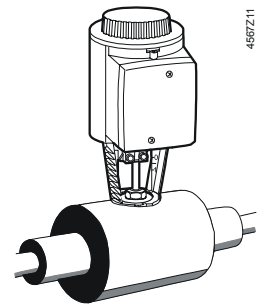

Observe admissible temperatures, refer to «Use» on page 1 and «Technical data» on page 12.

If an auxiliary switch is required, its switching point should be indicated on the plant schematic.

Every actuator must be driven by a dedicated controller (refer to «Connection diagrams», page 15).

## Mounting instructions

Mounting Instruction 74 319 0325 0 for fitting the actuator to the valve are by packed in the actuator packaging. The instructions for accessories are enclosed with the accessories themselves.

Accessories	Installation instructions		Accessory	Mounting instructions	
ASC1.6	G4563.3	4 319 5544 0	ASK50	M4561.5	4 319 5549 0
ASC9.3	G4561.3	4 319 5545 0	ASZ7.3...		74 319 0247 0
SKD...		74 319 0326 0	SKD...	M3250	74 319 0325 0
			ASZ6.6	M4501.1	74 319 0750 0

### Orientation

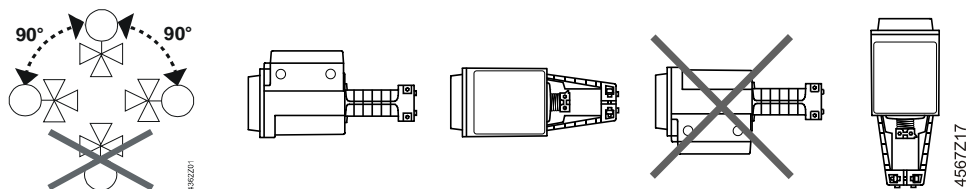

### Commissioning notes

When commissioning the system, check the wiring and functions, and set any auxiliary switches and potentiometers as necessary, or check the existing settings.

Coupling fully retracted  
→ stroke = 0%

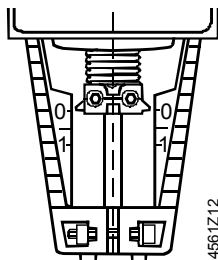

Coupling fully extended  
→ stroke = 100 %

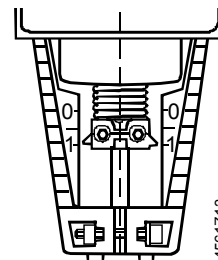

The manual adjuster must be rotated counterclockwise to the end stop, i.e. until the red indicator marked «MAN» is no longer visible. This causes the Siemens valves, types VVF..., VVG..., VXF.. and VXG.. to close (stroke = 0%).

Manual operation

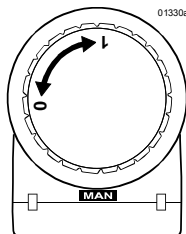

« MAN »

Automatic operation

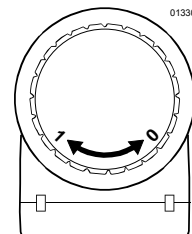

« AUTO »

## Maintenance notes

---

The SKD.. actuators are maintenance-free.



### When servicing the actuator:

- **Switch off pump of the hydronic loop**
- **Interrupt the power supply to the actuator**
- **Close the main shutoff valves in the system**
- **Release pressure in the pipes and allow them to cool down completely**
- **If necessary, disconnect electrical connections from the terminals**
- **The actuator must be correctly fitted to the valve before recommissioning.**

Recommendation SKD6...: trigger stroke calibration.

Repair

«Replacement parts», see page 18.



**Warning**

### A damaged housing or cover represents an injury risk

- **NEVER uninstall an actuator from the valve**
- **Uninstall the valve-actuator combination (actuating device) as a complete device**
- **Use only properly trained technicians to uninstall the unit**
- **Send the actuating device together with an error report to your local Siemens representative for analysis and disposal**
- **Properly mount the new actuating device (valve and actuator)**

Parts could fly ultimately resulting in injuries from uninstalling an actuator with a damaged valve housing due to the tensioned return spring.

## Disposal

---



The device is considered an electronics device for disposal in terms of European Directive 2012/19/EU and may not be disposed of as domestic garbage.

- Dispose of the device through channels provided for this purpose.
- Comply with all local and currently applicable laws and regulations.

## Warranty

---

Technical data on specific applications are valid only together with Siemens products listed under "Equipment combinations", page 3. Siemens rejects any and all warranties in the event that third-party products are used.

## Technical data

		SKD32..	SKD82..	SKD6..
Power supply	Operating voltage	AC 230 V	AC 24 V	AC 24 V
	Voltage tolerance	± 15 %	± 20 %	± 20 %
		SELV / PELV		
	Frequency	50 or 60 Hz		
Max. Power consumption At 50 Hz	SKD32.21:	16 VA / 12 W	SKD82.50, ..50U 9 VA / 7 W	SKD60.. 10 VA / 8 W
	SKD32.50:	11 VA / 8 W	SKD82.51, ..51U 14 VA / 10 W	SKD62.. 14 VA / 10 W
	SKD32.51:	17 VA, 12 W		
External supply cable fuse	min. 0.5 A, slow max. 6 A, slow	min. 1 A, slow max. 10 A, slow		
Signal inputs	Control signal	3-position		DC 0...10 V, DC 4...20 mA or 0...1000 Ω
	Terminal Y	Voltage Input impedance Current Input impedance Signal resolution Hysteresis		DC 0...10 V 100 kΩ DC 4...20 mA 240 Ω < 1% 1 %
	Terminal Z Override control	Resistor Z not connected, priority terminal Y Z connected directly to G Z connected directly to G0 Z connected to M via 0...1000 Ω		1000 Ω No function max. stroke 100 % min. stroke 0 % stroke proportional to R
	Terminal U	voltage load impedance current load impedance		DC 0...9.8 V ±2 % > 10 kΩ DC 4...19.6 mA ±2 % < 500 Ω
Position feedback				
Connecting cable	Cable cross-sectional area	0.5 ... 2.5 mm <sup>2</sup> / AWG 21 ... 14		
	Positioning time at 50 Hz <sup>1)</sup> opening	SKD32.21	30 s	30 s
		SKD32.5..	120 s	
	Closing	SKD32.21	10 s	15 s
SKD32.5..		120 s	SKD82.5.. 120 s	
Spring-return time <sup>1)</sup>	SKD32.21	8 s	SKD82.51 8 s	SKD62.. 15 s
Positioning force	1000 N			
Nominal stroke	20 mm			
Max. permissible medium temperature	-25...150 °C < 0 °C: requires stem heater ASZ6.6			
<sup>1)</sup> At room temperature (23°C), low ambient temperatures or high Δp may prolong these times				
Electrical connections Standards, directives and approvals	Cable entry	4 x M20 (Ø 20.5 mm) With knockouts for standard ½" conduit connectors (Ø 21.5 mm)		
	Product standard	EN 60730-x		
	Electromagnetic compatibility (Applications)	For use in residential, commercial, light-industrial and industrial environments		
	EU conformity (CE)	A5W00007752 <sup>1)</sup>		
	RCM-conformity (EMC)	A5W00007898 <sup>1)</sup>		
	AC 230 V			
	EAC conformity	Eurasia conformity for all SKD..		

	SKD32..	SKD82..	SKD6..
Environmental compatibility	UL certification: UL, cUL		
	AC 230 V -		
	AC 24 V UL 873, <a href="http://ul.com/database">http://ul.com/database</a>		
Environmental compatibility	The product environmental declarations CE1E4561en01 <sup>1)</sup> , CE1E4561en02 <sup>1)</sup> and CE1E4561en03 <sup>1)</sup> contain data on RoHS compliance, materials composition, packaging, environmental benefit and disposal.		
Dimensions / weight	Dimensions refer to «Dimensions», page 17		
	Weight (without packaging)		
Materials	ASK50 stroke inverter	1.10 kg	
	Actuator housing, bracket	Die-cast aluminum	
	Housing box and manual adjuster	Plastic	

<sup>1)</sup> The documents can be downloaded from <http://siemens.com/bt/download>.

### Accessories

	SKD32.., SKD82..	SKD6..
ASC1.6 Auxiliary switch	Switching capacity	AC 24 V, 10 mA...4 A resistive, 2 A inductive
ASC9.3 double auxiliary switch	Switching capacity per auxiliary switch	AC 250 V, 6 A resistive, 2.5 A inductive
ASZ7.3 Potentiometer	Change in overall resistance of potentiometer at nominal stroke	ASZ7.3 0...1000 Ω ASZ7.31 0...135 Ω ASZ7.32 0...200 Ω
	min. current in sliding contact	0,05 mA
	expected lifetime	250'000 full lifts
	max. current in sliding contact	2,5 mA
	expected lifetime	100'000 full lifts
ASZ6.6 stem heater	Operating voltage	AC 24 V ± 20 %
	Power consumption	40VA / 30 W
	Inrush current	Max. 8 A (B Series)

### SKD62UA enhanced functions

Direction of operation	Direct-acting, reverse-acting	DC 0...10 V / DC 10...0 V DC 4...20 mA / DC 20...4 mA 0...1000 Ω / 1000...0 Ω
Stroke limit control	Range of lower limit	0...45 % adjustable
	Range of upper limit	100...55 % adjustable
Sequence control	Terminal Y	
	Starting point of sequence	0...15 V adjustable
	Operating range of sequence	3...15 V adjustable
Signal addition	Z connected to R of	
	Frost protection monitor QAF21..	0...1000 Ω, added to Y signal
	Frost protection monitor QAF61..	DC 1.6 V, added to Y signal

## Ambient conditions and protection data

Classification to IEC/EN 60730	Automatic action: Type 1AA / Type 1AC / Modulation Action
	Pollution degree: 2
Housing protection as per IEC/EN 60529	IP54
Environmental conditions	
Transportation (in transport packaging) to IEC/EN 60721-3-2	Class 2K3 Temperature -30...65 °C Humidity 5...95 % (no condensation)
Operation to IEC/EN 60721-3-3	Class 3K5 Temperature -15...50 °C Humidity 5...95 % (no condensation)
Storage to IEC/EN 60721-3-1	Class 1K3 Temperature -15...50 °C Humidity 5...95 % (no condensation)

## Internal diagrams

### SKD32.51, SKD32.21 AC 230 V, 3-Position

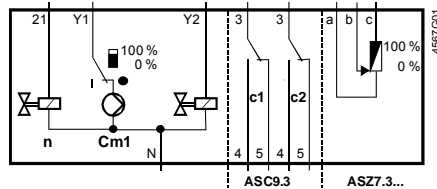

- Cm1** end switch
- n** solenoid valve for spring-return
- c1, c2** ASC9.3 double auxiliary switch
- a, b, c** ASZ7.. potentiometer
- Y1** Positioning signal «open»
- Y2** Positioning signal «close»
- Z1** spring-return function
- N** neutral conductor

### SKD32.50 AC 230 V, 3-Position

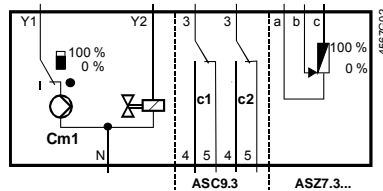

- Cm1** end switch
- n** solenoid valve for spring-return
- c1, c2** ASC9.3 double auxiliary switch
- a, b, c** ASZ7.. potentiometer
- Y1** Positioning signal «open»
- Y2** Positioning signal «close»
- Z1** spring-return function
- G** System potential

### SKD82.51 AC 24 V, 3-Position

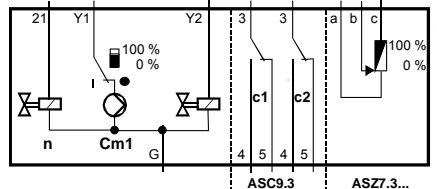

- Cm1** end switch
- n** solenoid valve for spring-return
- c1, c2** ASC9.3 double auxiliary switch
- a, b, c** ASZ7.. potentiometer
- Y1** Positioning signal «open»
- Y2** Positioning signal «close»
- Z1** spring-return function
- G** System potential

### SKD82.50 AC 24 V, 3-Position

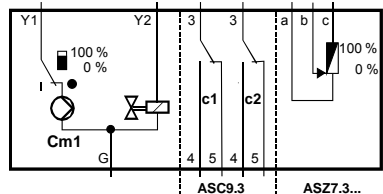

### SKD60, SKD60U, SKD62, SKD62U, SKD62UA AC 24 V, DC 0...10 V, 4...20 mA, 0...1000 Ω

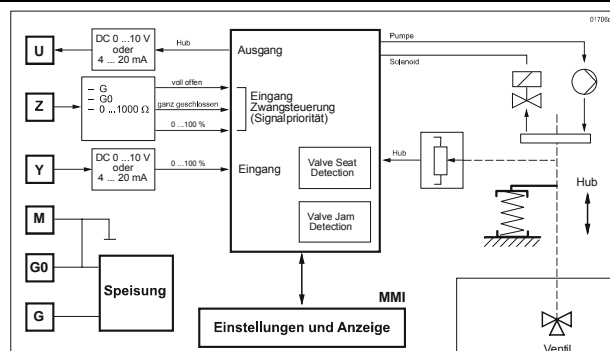

- U** position indication
- Z** override control
- Y** positioning signal
- M** measuring neutral
- G0** operating voltage AC 24 V: system neutral (SN)
- G** operating voltage AC 24 V: system potential (SP) Switching without power as a spring return function

## Connection terminals

### SKD6..

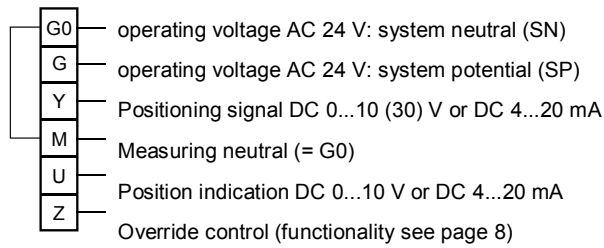

### Auxiliary switch ASC1.6

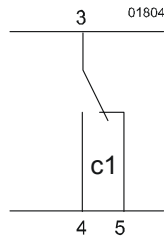

## Connection diagrams

### SKD32.. AC 230 V 3-Position

#### SKD32.21, SKD32.51

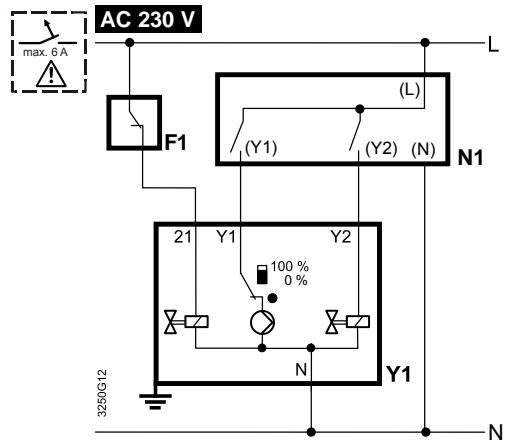

<b>F1</b>	safety limiter (eg. temperature limiter)	<b>L</b>	Phase
<b>N1, N2</b>	controller	<b>N</b>	neutral
<b>Y1, Y2</b>	actuators		

#### SKD32.50

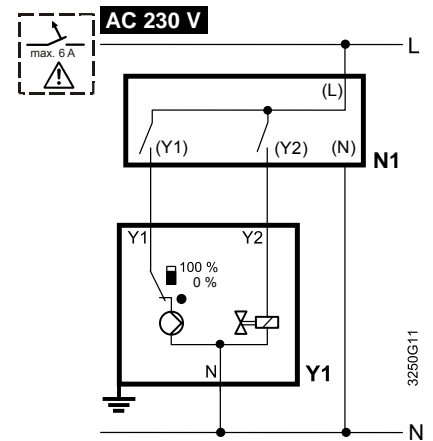

<b>Y1</b>	Positioning signal «open»
<b>Y2</b>	Positioning signal «close»
<b>21</b>	Spring-return function

**SKD82..**  
AC 24 V  
3-Position

**SKD82.51, SKD82.51U**

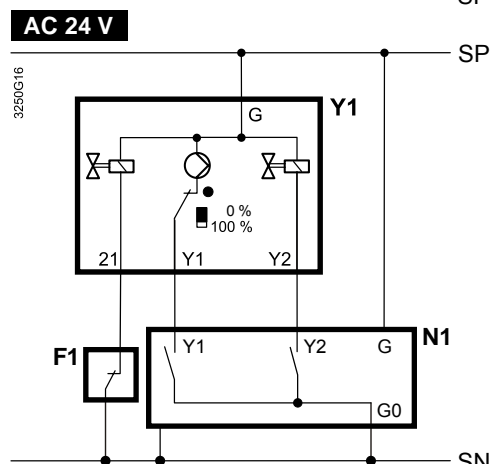
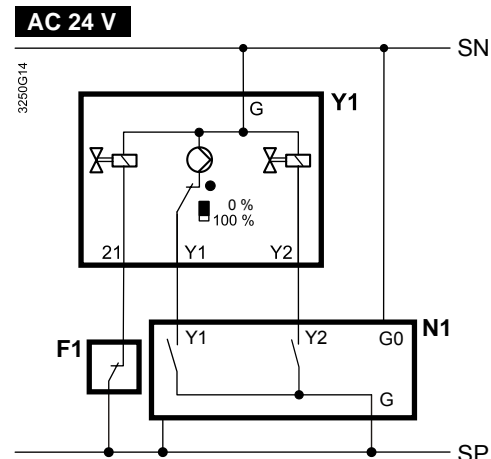

**F1** safety limiter (eg temperature limiter)  
**N1, N2** controller  
**Y1, Y2** actuators  
**SP** Systempotential AC 24 V  
**SN** System neutral

**SKD82.50, SKD82.50U**

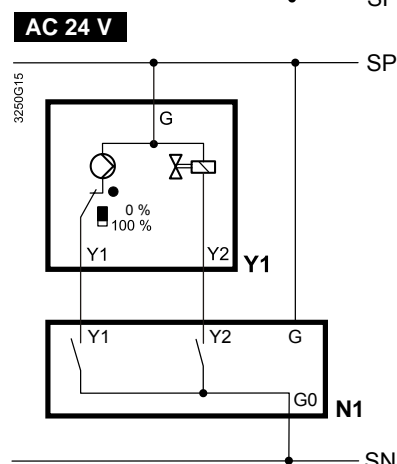
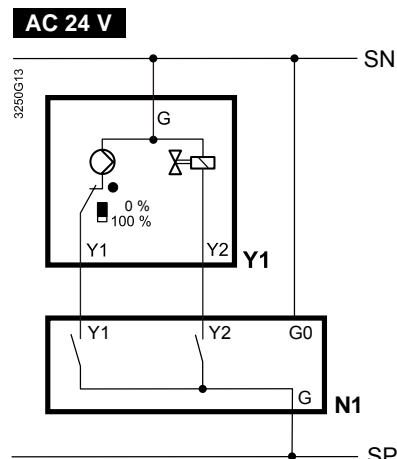

**(Y1), (Y2)** controller contacts  
**Y1** Positioning signal «open»  
**Y2** Positioning signal «close»  
**21** Spring-return function

**SKD6..**  
AC 24 V  
DC 0...10 V, 4...20 mA,  
0...1000 Ω

**SKD60**  
**SKD60U**

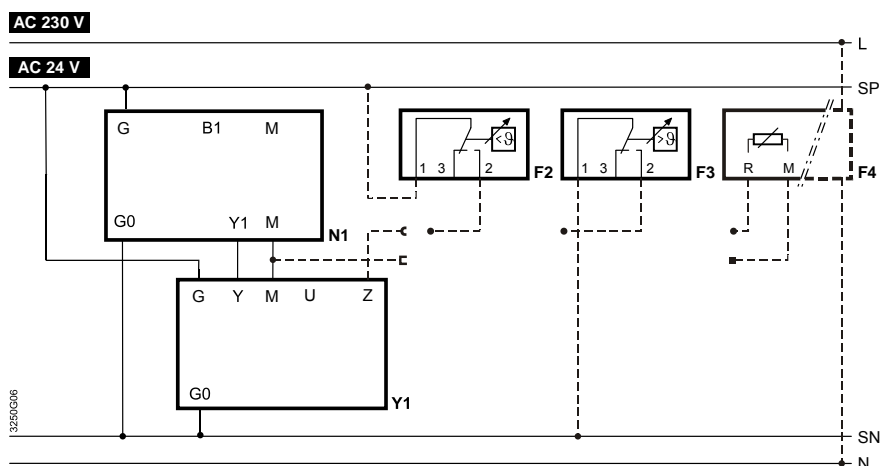



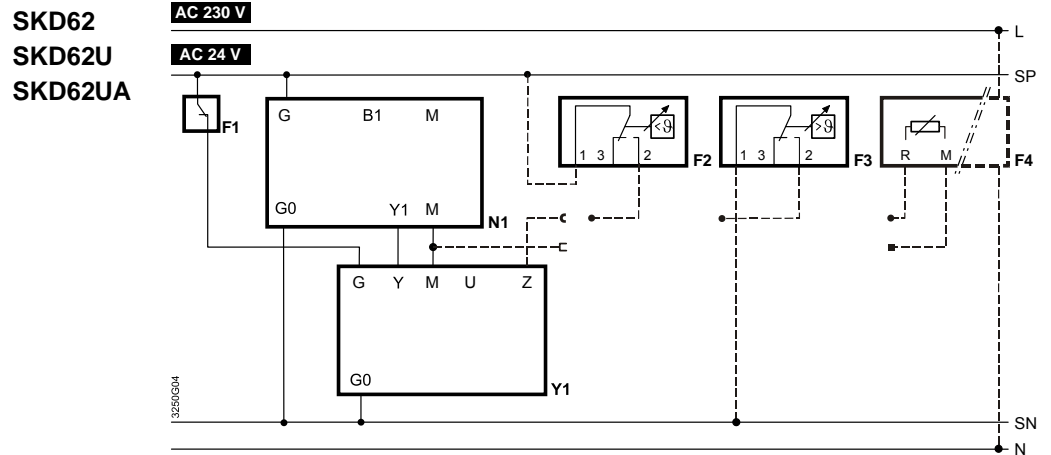

- Y1** actuator
- N1** controller
- F1** safety limiter (eg temperature limiter)
- F2** frost protection thermostat  
terminals: 1 – 2 frost hazard / sensor is interrupted (thermostat closes with frost)  
1 – 3 normal operation
- F3** Temperature detector
- F4** Frost protection monitor with 0...1000 Ω signal output, e.g. QAF21.. or QAF61.. (only SKC62UA) \*
- G (SP)** System potential AC 24 V
- G0 (SN)** System neutral

\* Only with sequence control and the appropriate selector switch settings (see page 5ff)

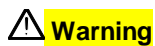

When using the safety limiter F1, ensure that no mistakes may occur on cable insulation that may cancel out the temperature limiter function (applies to both 230 V as well as 24 V types).

For SN earthing (e.g. PELV) comply under all circumstances with the note above.

## Dimensions

All dimensions in mm

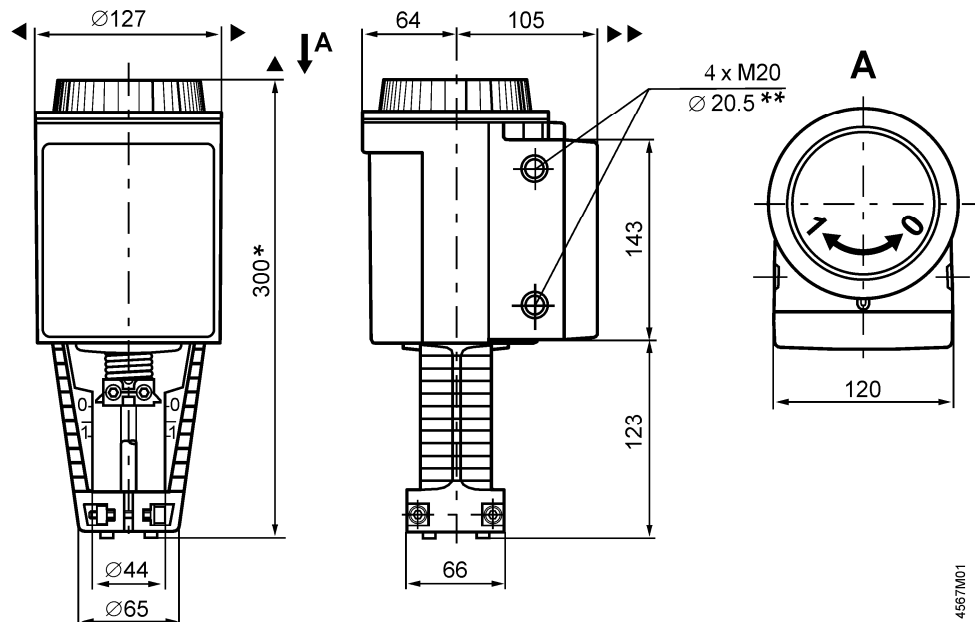

\* Height of actuator from valve plate without stroke inverter **ASK50 = 300 mm**  
Height of actuator from plate with stroke inverter **ASK50 = 357 mm**

\*\* SKD..U with knockouts for standard ½" conduit connectors (Ø 21.5 mm)

▶ = > 100 mm | Minimum clearance from ceiling or wall for mounting,

▶▶ = > 200 mm | connection, operation, maintenance etc.

4567/M01

## ASK50 stroke inverter

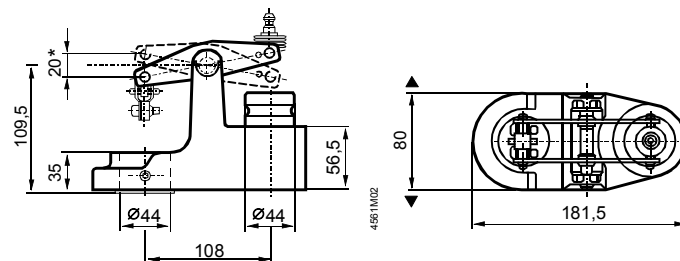

\* Maximum stroke = 20 mm

## Replacement parts

Order numbers for replacement parts

Actuator type	Cover	Hand control <sup>1)</sup>	Control unit
<b>SKD32.50</b>	410456348	426855048	
<b>SKD32.51</b>	410456348	426855048	
<b>SKD32.21</b>	410456348	426855048	
<b>SKD82.50</b>	410456348	426855048	
<b>SKD82.50U</b>	410456348	426855048	
<b>SKD82.51</b>	410456348	426855048	
<b>SKD82.51U</b>	410456348	426855048	
<b>SKD62</b>	410456348	426855048	466857488
<b>SKD62U</b>	410456348	426855048	466857488
<b>SKD60</b>	410456348	426855048	466857598
<b>SKD60U</b>	410456348	426855048	466857598
<b>SKD62UA</b>	410456348	426855048	466857518

1) hand control, blue with mechanical parts

## Revision numbers

Type reference	Valid from Rev.-No.	Type reference	Valid from Rev.-No.
SKD32.50	..F	SKD62	..H
SKD32.51	..F	SKD62U	..H
SKD32.21	..F	SKD60	..H
SKD82.50	..F	SKD60U	..H
SKD82.50U	..F	SKD62UA	..H
SKD82.51	..F		
SKD82.51U	..F		

Published by:  
Siemens Switzerland Ltd.  
Building Technologies Division  
International Headquarters  
Gubelstrasse 22  
6301 Zug  
Switzerland  
Tel. +41 41-724 24 24  
[www.siemens.com/buildingtechnologies](http://www.siemens.com/buildingtechnologies)

© Siemens Switzerland Ltd 1998  
Delivery and technical specifications subject to change